

# NIO-4SNDC

## 4" Iolite Square Reflector with Round Aperture

Source: 14W to 28W LED  
800lm to 2500lm

Type

Project

Catalog No.

Notes

### PRODUCT DESCRIPTION

4" Iolite LED downlights require a dedicated Iolite new construction or remodel housing. Deep regressed cone reflectors optimize visual cut-off.

### FEATURES

- 800lm, 1000lm, 1500lm, 2000lm or 2500lm LED packages
- 2700K, 3000K, 3500K, 4000K, 5000K @ 90+ CRI
- Comfort Dim (warm dimming) also available
- Flood optic, narrow flood and spot optics (included)
- 5-Year limited warranty

### SPECIFICATION

**Construction:** Trims are constructed of heat dissipating, die-cast aluminum. The aluminum die-cast LED heat sink is threaded to fit the trim and transfer heat.

**Mounting:** Luminaire includes friction blades to mount securely to housing.

### OPTICS

**800-1000lm:** Three field changeable optics (spot, narrow flood and flood) are included with each LED module. Premium 10° TIR narrow spot optic assembly also available ([Click Here](#) for more information). Optional frosted and TIR optics are also available.

**1500-2500lm:** Three field changeable TIR optics (spot, narrow flood and flood) are included with each LED module.

### ELECTRICAL

**Lumens / Wattage:** 800lm / 14W, 1000lm / 14W, 1500lm / 20W, 2000lm / 24W, 2500lm / 28W

**Color Temperature:** 2700K, 3000K, 3500K, 4000K, 5000K

**Color Rendering Index:** 90+CRI

**Operating Temperature:** Specified by housing

**Lifetime:** 50,000 hours @ L70

**Comfort Dim:** Comfort Dim color tunes the temperature from a bright 3100K (800lm) or 3000K (HL), to a romantic and comfortable 2000K on a gradual, even curve. Available in 800lm or HL (1500lm-2500lm).

**Dimming:** Specified by housing

### COMPATIBLE HOUSINGS

Luminaires are compatible with respective Iolite housings manufactured by Nora Lighting.

CATALOG NO.	DESCRIPTION	LUMENS / WATTAGE
<a href="#">NHIOICD-48</a>	ICAT New Construction	800-1000lm / 14W
<a href="#">NHIOICDP-48</a>	Chicago Plenum	800-1000lm / 14W
<a href="#">NHRIOIC-48</a>	ICAT Remodel	800-1000lm / 14W
<a href="#">NHIOICD-415</a>	ICAT New Construction	1500lm / 20W
<a href="#">NHIOICDP-415</a>	Chicago Plenum	1500lm / 20W
<a href="#">NHIOICD-420</a>	ICAT New Construction	2000lm / 24W
<a href="#">NHIOICDP-420</a>	Chicago Plenum	2000lm / 24W
<a href="#">NHIOICD-425</a>	ICAT New Construction	2500lm / 28W
<a href="#">NHIOICDP-425</a>	Chicago Plenum	2500lm / 28W

**Accessories:** Luminaires can accommodate (1) hex louver and (1) translucent deco collar or opaque snoot, no accessory holder is required, see accessories page. Flush mount mud ring is available to give the appearance of a trimless, compatible with new construction housing only.

### LABELS AND LISTINGS

- cULus Listed for Wet Locations
- [5-Year Limited Warranty](#)
- RoHS Compliant
- Certified to the high efficacy requirements of California Title 24 JA8-2022



### PRODUCT IMAGES & DIMENSIONS

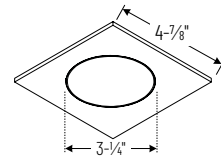

**NIO-4SNDC**  
Square Reflector with Round Aperture  
Non-Adjustable

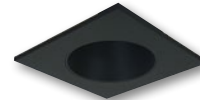

**BB**  
Black Reflector  
Black Flange

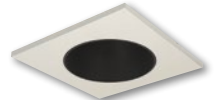

**BW**  
Black Reflector  
White Flange

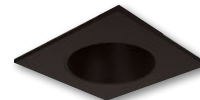

**BZ**  
Bronze Reflector  
Bronze Flange



**CHMPW**  
Champagne Haze Reflector  
Matte Powder White Flange

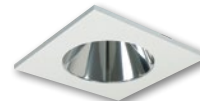

**CMPW**  
Specular Clear Reflector  
Matte Powder White Flange



**HW**  
Haze Reflector  
White Flange



**HZMPW**  
Haze Reflector  
Matte Powder White Flange



**MPW**  
Matte Powder White Reflector  
Matte Powder White Flange



**NN**  
Natural Metal Reflector  
Natural Metal Flange



**WW**  
White Reflector  
White Flange

### 4" Iolite Square Reflector with Round Aperture - Dedicated Housing Required

Color Temperature	Finish	Lumens / Wattage
<b>NIO-4SNDC50X</b> = 5000K*	<b>BB</b> = Black / Black	(blank) = 800lm / 14W
<b>NIO-4SNDCCDX</b> = Comfort Dim†	<b>BW</b> = Black / White	
<b>NIO-4SNDC27X</b> = 2700K	<b>BZ</b> = Bronze / Bronze	<b>/10</b> = 1000lm / 14W
<b>NIO-4SNDC30X</b> = 3000K	<b>CHMPW</b> = Champagne / Matte Powder White	<b>/HL</b> = 1500-2500lm
<b>NIO-4SNDC35X</b> = 3500K	<b>CMPW</b> = Specular Clear / Matte Powder White	(varies by housing)
<b>NIO-4SNDC40X</b> = 4000K	<b>HW</b> = Haze / White	
<b>NIO-4SNDC50X</b> = 5000K	<b>HZMPW</b> = Haze / Matte Powder White	
<b>NIO-4SNDCDX</b> = Comfort Dim†	<b>MPW</b> = Matte Powder White	
	<b>NN</b> = Natural Metal / Natural Metal	
	<b>WW</b> = White / White	

\* 5000K LED modules in 800lm are while supplies last

† Comfort Dim available in 800lm only and † Iolite uses a different dimming curve than 2" & 4" Iolite

### Compatible Housings

Housing Type
<b>NHIOICD-48</b> = ICAT New Construction / 800-1000lm / 14W
<b>NHIOICDP-48</b> = Chicago Plenum / 800-1000lm / 14W
<b>NHRIOIC-48</b> = ICAT Remodel / 800-1000lm / 14W
<b>NHIOICD-415</b> = ICAT New Construction / 1500lm / 20W
<b>NHIOICDP-415</b> = Chicago Plenum / 1500lm / 20W
<b>NHIOICD-420</b> = ICAT New Construction / 2000lm / 24W
<b>NHIOICDP-420</b> = Chicago Plenum / 2000lm / 24W
<b>NHIOICD-425</b> = ICAT New Construction / 2500lm / 28W
<b>NHIOICDP-425</b> = Chicago Plenum / 2500lm / 28W

Example: **NIO-4SNDC50XWW** = 4" Iolite Square Reflector with Round Aperture, 5000K, White finish, 800lm

# 4" Iolite Accessories

## 4" Iolite Square Reflector with Round Aperture

Type
Project
Catalog No.
Notes

### FIELD CHANGEABLE OPTICS

Iolite luminaires include spot, narrow flood and flood optics. Optics can be changed in the field by removing LED module from die-cast trim. Optional frosted and TIR optics are also available.

**Note:** Frosted and Premium TIR optics are not compatible with /HL LED modules.

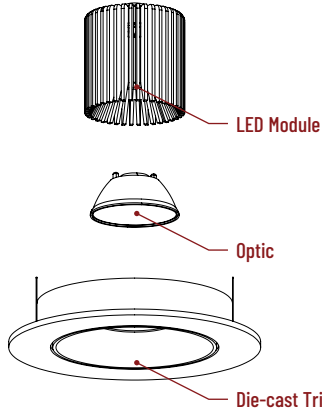

#### Frosted Optics

**NIO-REFL38FR** 60° Optic  
**NIO-REFL60FR** 73° Optic  
**Not compatible with /HL LED module.**

#### Premium TIR Optics

**NIO-REFLTIR15** 22° Optic  
**NIO-REFLTIR25** 26° Optic  
**Not compatible with /HL, Comfort Dim (CDX) LED modules or Hex Cell Louver.**

#### 10° TIR Optic Assembly

Specialized narrow spot LED module assembly is also available. Requires LE4 housing. [Click Here](#) for more information.

### ACCESSORIES

Iolite accessories can be added at any point in the design process. Accessories easily install between LED module and die-cast trim.

Luminaire will accommodate (1) hex louver and (1) collar accessory, no accessory holder required.

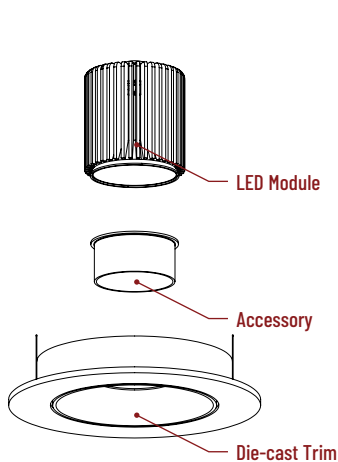

#### Translucent Decorative Collar

**NIO-AS14(color)** 5/8" length  
**NIO-AS19(color)** 3/4" length  
**NIO-AS26(color)** 1" length  
**Color:** AM (amber), BLU (blue), FR (frosted), R (red)

Translucent collars color the aperture with the specified color while producing white general light. Collars are available in different lengths. Use to add interest, create a theme, match a theme or define a space.

#### Opaque Collar Snoot

**NIO-AS14(color)** 5/8" length  
**NIO-AS19(color)** 3/4" length  
**NIO-AS26(color)** 1" length  
**Color:** MPW (matte powder white), WH (white)

Opaque snoot greatly reduces aperture brightness while preserving light output.

#### Hex Cell Louver

**NIO-HC** Black  
 Hex cell louver subtly reduces aperture brightness by reducing light output by about 20%.

**Hex cell louver is not compatible with TIR optics.**

### FLUSH MOUNT

4" Iolite trims can be installed flush with the drywall for a flush mount appearance. A flush mount mud ring is installed after the drywall and a professional drywall finisher floats the ceiling to blend in the mud ring.

#### Flush Mount Mud Ring

**NIO-FMMR-4S** Square Mud Ring

Mounts trim flush to ceiling with flange visible. Mud ring attaches to drywall. **Only for use with NH10ICD-48 or NH10ICDCP-48 new construction housings and NIO-4S reflectors.**  
 Dimensions: 7-7/8" diameter 1/2" thick



# PHOTOMETRICS

4" Iolite Square Reflector with Round Aperture  
1000 lumens

Type

Project

Catalog No.

Notes

## Test Information

Test Number: NTR11291  
Part Number: N10-4SNDC30XBW/10  
Beam Spread: 27° Spot  
Lumens: 1089lm  
Wattage: 13.53W  
Efficacy: 81lpw  
CCT / CRI: 3000K / 90 CRI  
Spacing Criteria (0°-180°): 0.46  
Spacing Criteria (90°-270°): 0.48

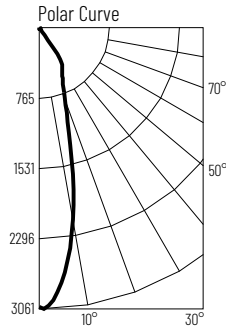

## Illuminance at a Distance

Distance from Luminaire	FC at Nadir	Beam Diameter
4'	189fc	1'-11"
6'	84.1fc	2'-11"
8'	47.3fc	3'-11"
10'	30.3fc	4'-10"
12'	21fc	5'-10"

## Zonal Lumen Summary

Zone	Lumens	% Luminaire
0-30	884	81.1
0-40	1062	97.5
0-60	1085	99.6
0-90	1085	99.6
90-180	4	0.4
0-180	1089	100

## Candela Table

Vertical Angles	Candela
0	3027
5	2721
15	1292
25	586
35	329
45	24

## Test Information

Test Number: NTR11230  
Part Number: N10-4SNDC30XBW/10  
Beam Spread: 41° Narrow Flood  
Lumens: 1059lm  
Wattage: 13.42W  
Efficacy: 79lpw  
CCT / CRI: 3000K / 90 CRI  
Spacing Criteria (0°-180°): 0.66  
Spacing Criteria (90°-270°): 0.66

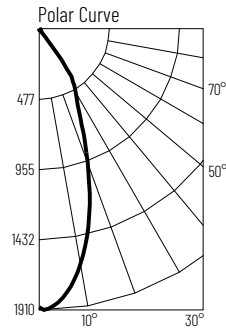

## Illuminance at a Distance

Distance from Luminaire	FC at Nadir	Beam Diameter
4'	118fc	3'
6'	52.6fc	4'-6"
8'	29.6fc	5'-11"
10'	18.9fc	7'-5"
12'	13.1fc	8'-11"

## Zonal Lumen Summary

Zone	Lumens	% Luminaire
0-30	851	80.4
0-40	1028	97
0-60	1055	99.6
0-90	1055	99.7
90-180	4	0.3
0-180	1059	100

## Candela Table

Vertical Angles	Candela
0	1893
5	1805
15	1305
25	681
35	279
45	19

## Test Information

Test Number: NTR11232  
Part Number: N10-4SNDC30XBW/10  
Beam Spread: 60° Flood  
Lumens: 1042lm  
Wattage: 13.5W  
Efficacy: 77lpw  
CCT / CRI: 3000K / 90 CRI  
Spacing Criteria (0°-180°): 0.9  
Spacing Criteria (90°-270°): 0.88

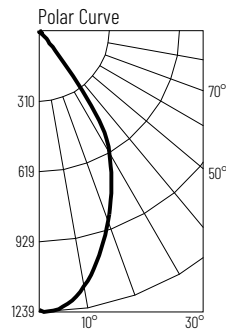

## Illuminance at a Distance

Distance from Luminaire	FC at Nadir	Beam Diameter
4'	76.6fc	4'-6"
6'	34fc	6'-8"
8'	19.1fc	9'
10'	12.2fc	11'-2"
12'	8.5fc	13'-6"

## Zonal Lumen Summary

Zone	Lumens	% Luminaire
0-30	744	71.4
0-40	979	94
0-60	1037	99.6
0-90	1038	99.7
90-180	4	0.3
0-180	1042	100

## Candela Table

Vertical Angles	Candela
0	1225
5	1194
15	1024
25	767
35	367
45	57

## Lumen Output Multipliers

Color Temperature: 2700K (0.98), 3000K (1.00), 3500K (1.09), 4000K (1.19), 5000K (1.16)

# PHOTOMETRICS

## 4" Iolite Square Reflector with Round Aperture 1500 lumens

Type

Project

Catalog No.

Notes

### Test Information

Test Number: NTR1659R1  
Part Number: N10-4SNDC30XWW/HL  
Beam Spread: 42° Spot  
Lumens: 1744lm  
Wattage: 19.4W  
Efficacy: 90lpw  
CCT / CRI: 3000K / 90 CRI  
Spacing Criteria (0°-180°): 0.7  
Spacing Criteria (90°-270°): 0.7

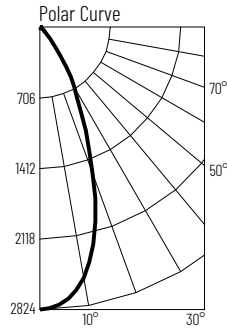

### Illuminance at a Distance

Distance from Luminaire	FC at Nadir	Beam Diameter
6'	78.4fc	4'-8"
8'	44.1fc	6'-4"
10'	28.2fc	7'-10"
12'	19.6fc	9'-5"
14'	14.4fc	10'-11"

### Zonal Lumen Summary

Zone	Lumens	% Luminaire
0-30	1318	75.5
0-40	1574	90.3
0-60	1698	97.3
0-90	1733	99.4
90-180	11	0.6
0-180	1744	100

### Candela Table

Vertical Angles	Candela
0	2824
5	2755
15	2126
25	1043
35	417
45	100

### Test Information

Test Number: NTR1661R1  
Part Number: N10-4SNDC30XWW/HL  
Beam Spread: 54° Narrow Flood  
Lumens: 1915lm  
Wattage: 19.4W  
Efficacy: 99lpw  
CCT / CRI: 3000K / 90 CRI  
Spacing Criteria (0°-180°): 0.88  
Spacing Criteria (90°-270°): 0.86

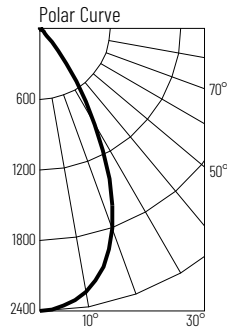

### Illuminance at a Distance

Distance from Luminaire	FC at Nadir	Beam Diameter
6'	66.7fc	6'-1"
8'	37.5fc	8'-2"
10'	24fc	10'-2"
12'	16.7fc	12'-4"
14'	12.2fc	14'-4"

### Zonal Lumen Summary

Zone	Lumens	% Luminaire
0-30	1422	74.3
0-40	1765	92.1
0-60	1879	98.1
0-90	1903	99.4
90-180	12	0.6
0-180	1915	100

### Candela Table

Vertical Angles	Candela
0	2400
5	2365
15	2095
25	1408
35	547
45	86

### Test Information

Test Number: NTR1663R1  
Part Number: N10-4SNDC30XWW/HL  
Beam Spread: 66° Flood  
Lumens: 1591lm  
Wattage: 19.26W  
Efficacy: 83lpw  
CCT / CRI: 3000K / 90 CRI  
Spacing Criteria (0°-180°): 1.02  
Spacing Criteria (90°-270°): 1.02

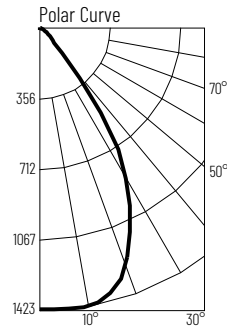

### Illuminance at a Distance

Distance from Luminaire	FC at Nadir	Beam Diameter
6'	39.4fc	7'-10"
8'	22.1fc	10'-6"
10'	14.2fc	13'-1"
12'	9.8fc	15'-8"
14'	7.2fc	18'-4"

### Zonal Lumen Summary

Zone	Lumens	% Luminaire
0-30	1016	63.9
0-40	1354	85.1
0-60	1533	96.4
0-90	1582	99.5
90-180	9	0.6
0-180	1591	100

### Candela Table

Vertical Angles	Candela
0	1417
5	1420
15	1383
25	1083
35	594
45	104

### Lumen Output Multipliers

Color Temperature: 2700K (0.92), 3000K (1.00), 3500K (1.1), 4000K (1.12), 5000K (1.18)

# PHOTOMETRICS

## 4" Iolite Square Reflector with Round Aperture 2000 lumens

Type

Project

Catalog No.

Notes

### Test Information

Test Number: NTR1660R1  
Part Number: N10-4SNDC30XWW/HL  
Beam Spread: 43° Spot  
Lumens: 2047lm  
Wattage: 23.38W  
Efficacy: 88lpw  
CCT / CRI: 3000K / 90 CRI  
Spacing Criteria (0°-180°): 0.7  
Spacing Criteria (90°-270°): 0.7

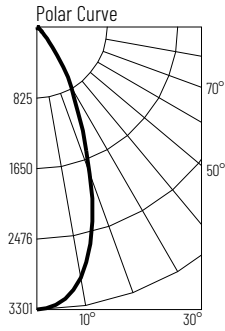

### Illuminance at a Distance

Distance from Luminaire	FC at Nadir	Beam Diameter
12'	22.9fc	9'-5"
14'	16.8fc	11'
16'	12.9fc	12'-7"
18'	10.2fc	14'-1"
20'	8.3fc	15'-8"

### Zonal Lumen Summary

Zone	Lumens	% Luminaire
0-30	1545	75.5
0-40	1847	90.3
0-60	1992	97.3
0-90	2034	99.4
90-180	13	0.6
0-180	2047	100

### Candela Table

Vertical Angles	Candela
0	3301
5	3208
15	2461
25	1248
35	481
45	117

### Test Information

Test Number: NTR1662R1  
Part Number: N10-4SNDC30XWW/HL  
Beam Spread: 54° Narrow Flood  
Lumens: 2249lm  
Wattage: 23.4W  
Efficacy: 96lpw  
CCT / CRI: 3000K / 90 CRI  
Spacing Criteria (0°-180°): 0.88  
Spacing Criteria (90°-270°): 0.86

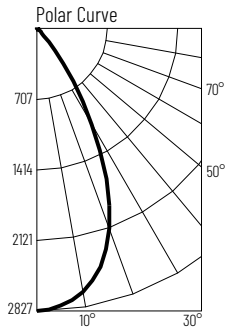

### Illuminance at a Distance

Distance from Luminaire	FC at Nadir	Beam Diameter
12'	19.6fc	12'-4"
14'	14.4fc	14'-4"
16'	11fc	16'-4"
18'	8.7fc	18'-5"
20'	7.1fc	20'-5"

### Zonal Lumen Summary

Zone	Lumens	% Luminaire
0-30	1671	74.3
0-40	2072	92.1
0-60	2206	98.1
0-90	2234	99.4
90-180	15	0.6
0-180	2249	100

### Candela Table

Vertical Angles	Candela
0	2827
5	2783
15	2473
25	1652
35	628
45	107

### Test Information

Test Number: NTR1664R1  
Part Number: N10-4SNDC30XWW/HL  
Beam Spread: 66° Flood  
Lumens: 1878lm  
Wattage: 23.43W  
Efficacy: 80lpw  
CCT / CRI: 3000K / 90 CRI  
Spacing Criteria (0°-180°): 1.02  
Spacing Criteria (90°-270°): 1.02

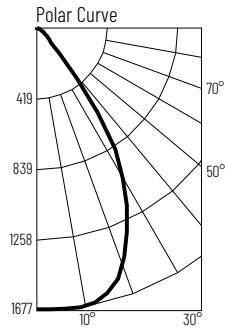

### Illuminance at a Distance

Distance from Luminaire	FC at Nadir	Beam Diameter
12'	11.6fc	15'-8"
14'	8.5fc	18'-4"
16'	6.5fc	20'-11"
18'	5.2fc	23'-6"
20'	4.2fc	26'-1"

### Zonal Lumen Summary

Zone	Lumens	% Luminaire
0-30	1199	63.9
0-40	1598	85.1
0-60	1808	96.4
0-90	1867	99.5
90-180	11	0.6
0-180	1878	100

### Candela Table

Vertical Angles	Candela
0	1672
5	1675
15	1628
25	1278
35	700
45	121

### Lumen Output Multipliers

Color Temperature: 2700K (0.94), 3000K (1.00), 3500K (1.13), 4000K (1.13), 5000K (1.2)