

# LSP-50 4.4W Indoor Flexible LED Strip

JOB NAME: \_\_\_\_\_  
LOCATION: \_\_\_\_\_  
QUOTE/REF#: \_\_\_\_\_

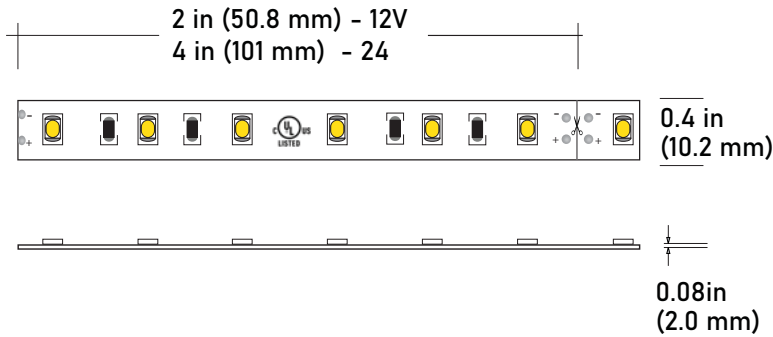







LSP-50 is a dimmable flexible LED strip capable of delivering 380 lumens of light output per ft. This LED strip is rated to last 50,000 hours making it an excellent replacement for halogen lighting. Its innovative low profile design makes it suitable for use in cove lighting, under cabinets, architectural and aesthetic enhancements.

## SPECIFICATIONS

<b>INPUT VOLTAGE</b>	24V DC
<b>POWER CONSUMPTION</b>	4.4W per foot
<b>LUMEN OUTPUT</b>	380 Lumens per foot
<b>NO. OF LEDs</b>	18 LEDs per foot
<b>BEAM ANGLE</b>	120°
<b>CRI</b>	95+
<b>DIMMING</b>	MLV, ELV, 0-10 and TRIAC
<b>MAXIMUM RUN LENGTH</b>	16.4 Feet (12V) 24 Feet (24V)
<b>FIELD CUTTABLE</b>	Every 2 in (12V) Every 4 in (24V)
<b>IP RATING</b>	IP45 dry location (indoor)
<b>LUMEN MAINTENANCE</b>	50,000 hrs.
<b>OPERATING TEMPERATURE</b>	-40°F(-40°C)~+140°F(+60°C)
<b>BINNING</b>	1.5 Step Macadam Ellipse
<b>CERTIFICATIONS</b>	UL listed, TITLE 24 JA8
<b>DIMENSIONS</b>	0.4" x 0.08 (width x height)

## FEATURES

- 4.4W per Foot
- 380 Lumens
- 95+ CRI
- California TITLE 24 JA8 compliant
- Field cuttable
- Suitable for accent or ambient lighting
- Multiple CCT options available
- Superior COLOR RENDERING INDEX (CRI)
- Available in 24V
- UL Listed
- Dimmable with CORE Lighting dimmable drivers

	COLOR TEMP	CRI	LUMEN/FT
	2500K	95	356
	2700K	95	356
	3000K	95	360
	3500K	95	368
	4000K	95	372
	5000K	95	376
	6000K	97	380



# LSP-50 4.4W Indoor Flexible LED Strip

## STANDARD ORDERING CODE

Model	Color Temp	Length	Voltage	Profile
LSP-50	<b>25K</b> 2500K	<b>16</b> 16.4 Ft.	<b>24</b> 24 Volts	<sup>2</sup> See p3 for options
	<b>27K</b> 2700K	<b>100</b> 100 Ft.		
	<b>30K</b> 3000K	<b>1XX</b> per Ft.		
	<b>35K</b> 3500K			
	<b>40K</b> 4000K			
	<b>50K</b> 5000K			
	<b>60K</b> 6000K			

### NOTE:

- 1** = Custom length per Ft. cuttable every 4
- 2** = Custom color finishes require powder coating. Allow 7 days lead time.

## COMPATIBLE ALUMINUM PROFILES

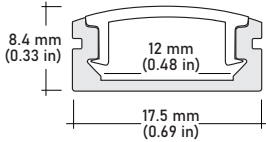

**ALU-SF** Surface  
**LENGTHS** 39<sup>3/8</sup>" | 78<sup>7/8</sup>" 84" | 98"  
**LENS** Clear, Frosted  
**FINISH** Silver | Black

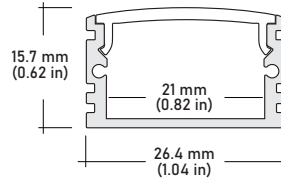

**ALU-DS100** Surface Wide 39<sup>3/8</sup>"  
**LENGTHS** | 78<sup>7/8</sup>" | 84"  
**LENS** Clear, Frosted  
**FINISH** Silver

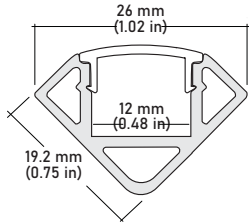

**ALU-CN** Surface, Corner 39<sup>3/8</sup>" |  
**LENGTHS** 78<sup>7/8</sup>" | 84" | 96"  
**LENS** Clear, Frosted  
**FINISH** Silver | Black

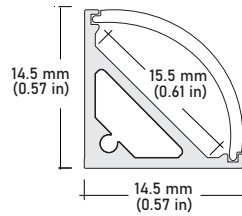

**ALP-50C** Surface, Corner  
**LENGTHS** 49.25" | 84" | 98.5"  
**LENS** Frosted  
**FINISH** White | Black | Silver

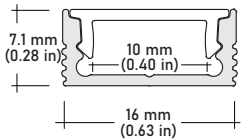

**ALP-20** Surface  
**LENGTHS** 49.25" | 98.5"  
**LENS** Frosted  
**FINISH** White | Black | Silver

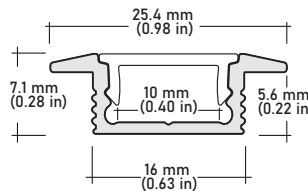

**ALP-20R** Recessed  
**LENGTHS** 49.25" | 98.5"  
**LENS** Frosted  
**FINISH** White | Black | Silver

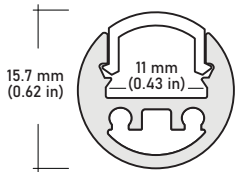

**ALP-35** Surface  
**LENGTHS** 48" | 96"  
**LENS** Frosted  
**FINISH** Silver

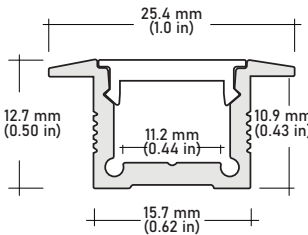

**ALP-60R** Recessed  
**LENGTHS** 49.25" | 98.5"  
**LENS** Frosted  
**FINISH** White | Black | Silver

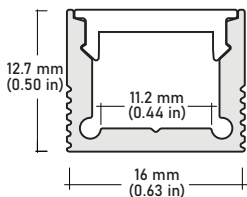

**ALP-60** Surface  
**LENGTHS** 49.25" | 98.5"  
**LENS** Frosted  
**FINISH** White | Black | Silver

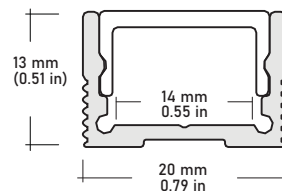

**ALP-70** Surface  
**LENGTHS** 49.25" | 84" | 98.5"  
**LENS** Frosted  
**FINISH** White | Black | Silver

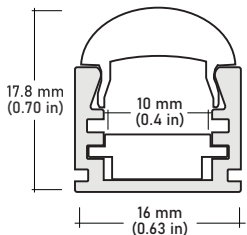

**ALP-65** Surface  
**LENGTHS** 49.25" | 98.5"  
**LENS** Frosted  
**FINISH** Silver  
**OPTICS** 10° | 30° | 60°

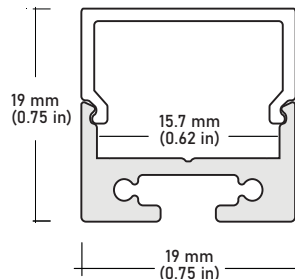

**ALP-80** Surface, Suspended  
**LENGTHS** 49.25" | 98.5"  
**LENS** Frosted  
**FINISH** Silver

## COMPATIBLE TRANSFORMERS

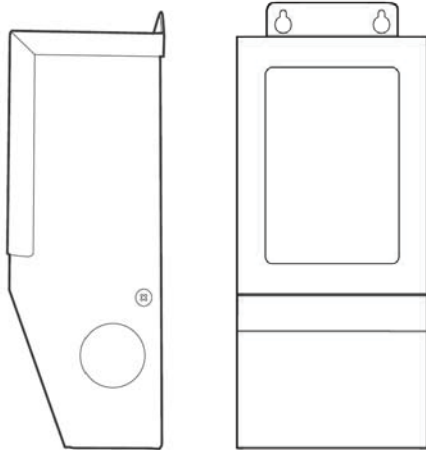

### PSDM 24V SERIES | DIMMABLE MAGNETIC LOW VOLTAGE (MLV)

<b>PSDM-20W-24V</b>	CLASS 2	5.6" x 2" x 2.14"
<b>PSDM-40W-24V</b>	CLASS 2	5.6" x 2" x 2.14"
<b>PSDM-60W-24V</b>	CLASS 2	6.5" x 2.3" x 2.5"
<b>PSDM-100W-24V</b>	CLASS 2	6.5" x 2.3" x 2.5"
<b>PSDM-150W-24V</b>		9.8" x 3" x 3"
<b>PSDM-192W-24V</b>	CLASS 2	7.0" x 7.0" x 3.2"
<b>PSDM-200W-24V</b>		9.8" x 3" x 3"
<b>PSDM-288W-24V</b>	CLASS 2	9.8" x 4.2" x 3.5"
<b>PSDM-300W-24V</b>		7.0" x 7.0" x 3.2"

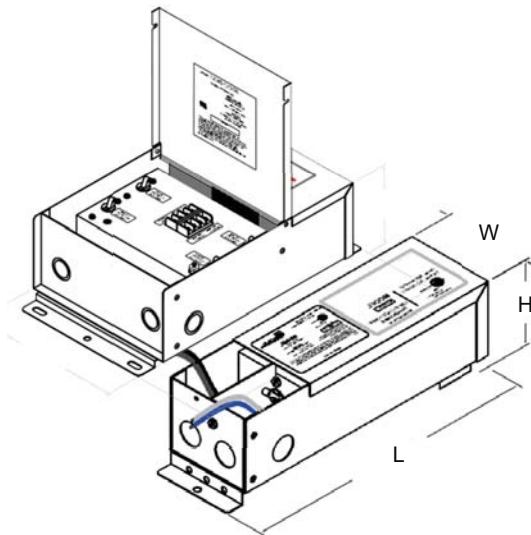

### PSDH SERIES | HIGH PERFORMANCE MAGNETIC LOW VOLTAGE (MLV)

<b>PSDH-48W-24V</b>	CLASS 2	11.25" x 3.37" x 3.25"
<b>PSDH-96W-24V</b>	CLASS 2	11.25" x 3.37" x 3.25"
<b>PSDH-288W-24V</b>	CLASS 2	14.25" x 8.43" x 4.43"

## COMPATIBLE TRANSFORMERS

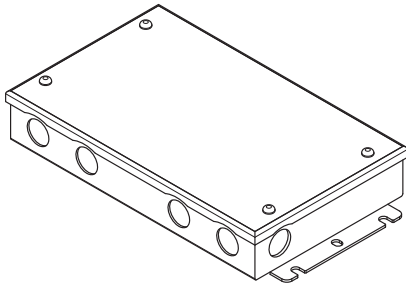

### PSDL SERIES | TRIAC DIMMABLE

<b>PSDL-30W-24V</b>	CLASS 2	6.5"x 3.63"x 1.03"
<b>PSDL-60W-24V</b>	CLASS 2	7.4"x 3.63"x 1.03"
<b>PSDL-96W-24V</b>	CLASS 2	8.67"x 3.67"x 1.62"
<b>PSDL-150W-24V</b>		8.67"x 3.67"x 1.62"
<b>PSDL-192W-24V</b>	CLASS 2	10.25"x 4.06"x 1.82"
<b>PSDL-200W-24V</b>		10.25"x 4.06"x 1.82"
<b>PSDL-288W-24V</b>	CLASS 2	10.25"x 4.06"x 1.82"
<b>PSDL-300W-24V</b>		10.25"x 4.06"x 1.82"

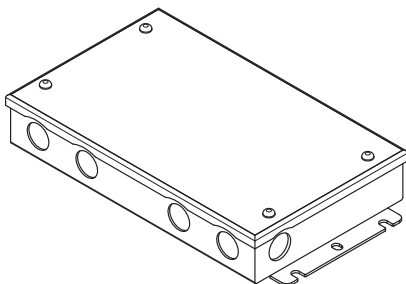

### PSHK SERIES | NON-DIMMING W/ JUNCTION BOX

<b>PSHK-30W-24V-UNV</b>	CLASS 2	6.5" X 3.6" X 1.02"
<b>PSHK-60W-24V-UNV</b>	CLASS 2	7.4" X 3.62" X 1.02"
<b>PSHK-96W-24V-UNV</b>	CLASS 2	8.66" X 3.66" X 1.61"
<b>PSHK-150W-24V-UNV</b>		10.24" X 4.06" X 1.81"
<b>PSHK-200W-24V-UNV</b>		10.24" X 4.06" X 1.81"
<b>PSHK-300W-24V-UNV</b>		10.94" X 4.25" X 1.81"

# LSP-50 4.4W Indoor Flexible LED Strip

## COMPATIBLE TRANSFORMERS

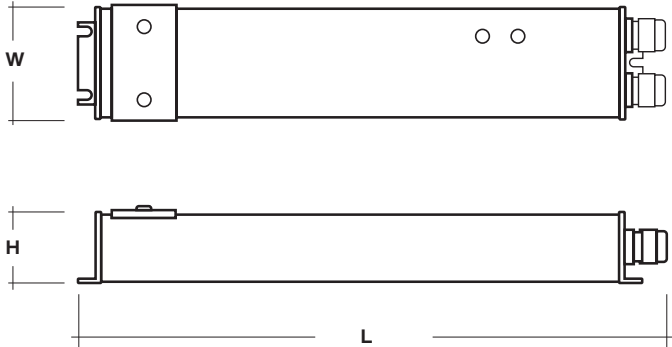

**PSDE SERIES** | 0-10V DIMMING W/ JUNCTION BOX

**PSDE-100W-24V-010-JB** CLASS 2 12.32" x 1.77" x 1.67"

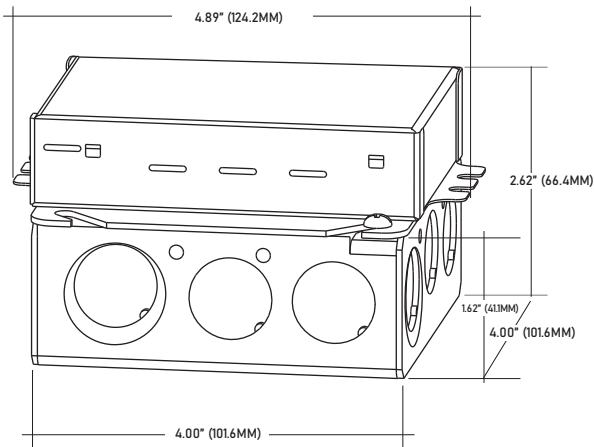

**LUTRON 1%** | 2 OR 3-WIRE DIMMING

**LTEA4U1UKL-CV240** CLASS 2 4.0" x 1.5" x 4.0"

**L3DA4U1UKL-CV240** CLASS 2 4.0" x 1.5" x 4.0"

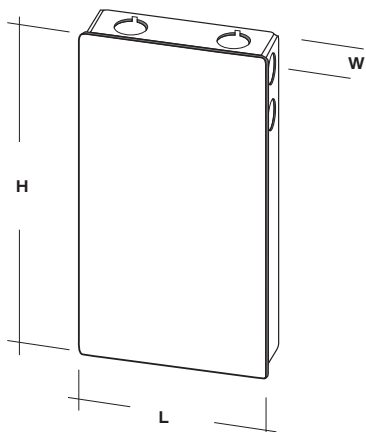

**LUTRON 1%**

**PSDE-96W-24V-ECO** CLASS 2 10.5" x 3.0" x 2.0"

## COMPATIBLE CONNECTORS



### HP PRO CONNECTORS | QUICK CONNECT SNAP-ON

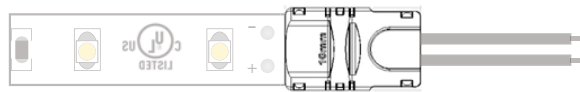

<b>LSA-HW8-HP</b>	8" CONNECTOR	0.95" x 0.57" x 0.30"
<b>LSA-HW24-HP</b>	24" CONNECTOR	0.95" x 0.57" x 0.30"
<b>LSA-HW60-HP</b>	60" CONNECTOR	0.95" x 0.57" x 0.30"
<b>LSA-HW120-HP</b>	120" CONNECTOR	0.95" x 0.57" x 0.30"



<b>LSA-EX3-HP</b>	3" LINK	0.95" x 0.57" x 0.30"
<b>LSA-EX8-HP</b>	8" LINK	0.95" x 0.57" x 0.30"
<b>LSA-EX24-HP</b>	24" LINK	0.95" x 0.57" x 0.30"

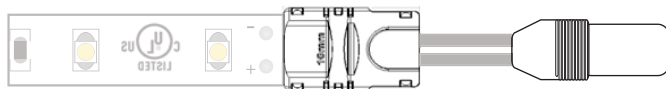

<b>LSA-DC24-HP</b>	24" DC CONNECTOR	0.95" x 0.57" x 0.30"
--------------------	------------------	-----------------------

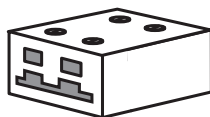

### LSA-TB | SOLDERLESS LED STRIP / WIRE BLOCK CONNECTOR

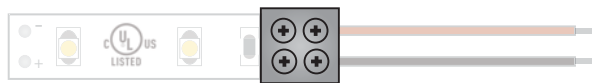

<b>LSA-TB-HWC</b>	6A HARDWIRE CONNECTOR	0.43" x 0.47" x 0.31"
-------------------	-----------------------	-----------------------

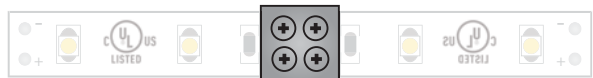

<b>LSA-TB-MC</b>	STRIP TO STRIP COUPLING	0.43" x 0.47" x 0.31"
------------------	-------------------------	-----------------------

<b>LSA-TB-HWP-10A</b>	10A HARDWIRE CONNECTOR	0.55" x 0.55" x 0.35"
-----------------------	------------------------	-----------------------