

# LSM75HF

7W Indoor Flexible LED Strip

JOB NAME: \_\_\_\_\_  
LOCATION: \_\_\_\_\_  
QUOTE/REF#: \_\_\_\_\_

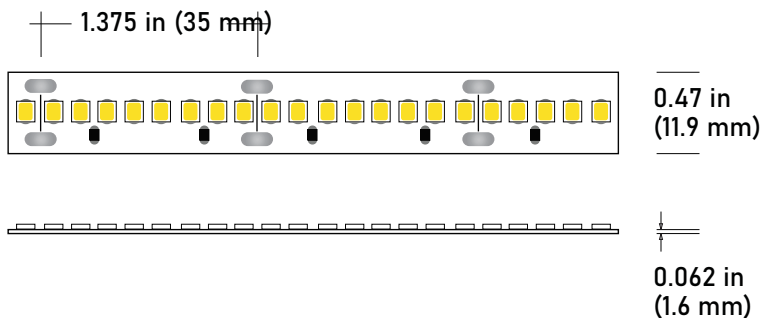

**LSM75HF** High Output Flexible LED strip is designed to produce more than 784 Lumens at 7.0 Watts per foot. This field cuttable LED strip features a low profile design that allows it to be attached almost anywhere. It is suitable for most common lighting applications. The **LSM75HF** produces a 120° light beam spread and is available in different color temperatures to fit your specific needs. UL listed.





## SPECIFICATIONS

<b>INPUT VOLTAGE</b>	24V DC
<b>POWER CONSUMPTION</b>	7W per foot
<b>LUMEN OUTPUT</b>	784 Lumens per foot
<b>NO. OF LEDs</b>	72 LEDs per foot
<b>BEAM ANGLE</b>	120°
<b>CRI</b>	95+
<b>DIMMING</b>	MLV, ELV, 0-10 and TRIAC
<b>MAXIMUM RUN LENGTH</b>	20 Feet
<b>FIELD CUTTABLE</b>	Every 1.375 in (35mm)
<b>IP RATING</b>	IP54 dry location (indoor)
<b>LUMEN MAINTENANCE</b>	50,000 hrs.
<b>OPERATING TEMPERATURE</b>	-40°F(-40°C)~+140°F(+60°C)
<b>BINNING</b>	1.5 Step Macadam Elipse
<b>CERTIFICATIONS</b>	UL listed, TITLE 24 JA8
<b>DIMENSIONS</b>	0.47" x 0.06 (width x height)

## FEATURES

- 7W per Foot
- 784 Lumens
- 95+ CRI
- California TITLE 24 JA8 compliant
- High efficacy level
- Suitable for accent or ambient lighting
- Multiple CCT options available
- Superior COLOR RENDERING INDEX (CRI)
- Available in 24V
- Dimmable with CORE Lighting dimmable drivers

	COLOR TEMP	CRI	LUMEN/FT
--	------------	-----	----------

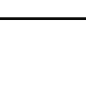
	2700K	95	763
	3000K	95	770
	3500K	93	784
	4000K	92	819
	5000K	89	826



## STANDARD ORDERING CODE

Model	Color Temp	Length	Voltage	Profile
LSM-75HF	27K 2700K	16 16.4 Ft.	24 24 Volts	<sup>2</sup> See p3 for options
	30K 3000K	100 100 Ft.		
	35K 3500K	'XX per Ft.		
	40K 4000K			
	50K 5000K			

### NOTE:

- 1** = Custom length per Ft. cuttable every 1.3"
- 2** = Custom color finishes require powder coating. Allow 7 days lead time.

## COMPATIBLE ALUMINUM PROFILES

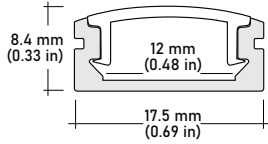

**ALU-SF** Surface  
**LENGTHS** 39<sup>3/8</sup>" | 78<sup>7/8</sup>" | 98"  
**LENS** Clear, Frosted  
**FINISH** Silver | Black

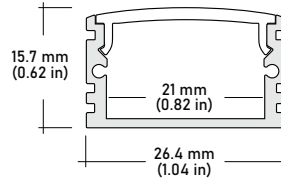

**ALU-DS100** Surface Wide  
**LENGTHS** 39<sup>3/8</sup>" | 78<sup>7/8</sup>" | 96"  
**LENS** Clear, Frosted  
**FINISH** Silver

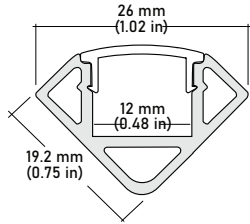

**ALU-CN** Surface, Corner  
**LENGTHS** 39<sup>3/8</sup>" | 78<sup>7/8</sup>" | 96"  
**LENS** Clear, Frosted  
**FINISH** Silver | Black

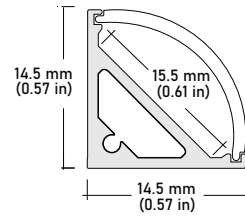

**ALP-50C** Surface, Corner  
**LENGTHS** 49.25" | 98.5"  
**LENS** Frosted  
**FINISH** White | Black | Silver

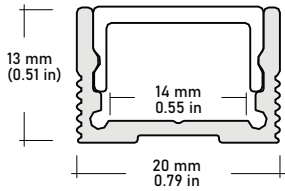

**ALP-70** Surface  
**LENGTHS** 49.25" | 98.5"  
**LENS** Frosted  
**FINISH** White | Black | Silver

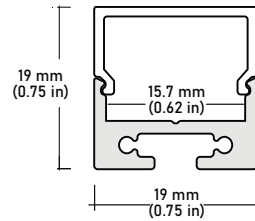

**ALP-80** Surface, Suspended  
**LENGTHS** 49.25" | 98.5"  
**LENS** Frosted  
**FINISH** Silver

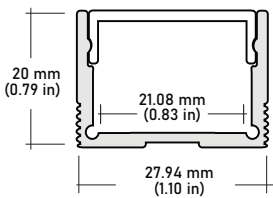

**ALP-130** Surface, Suspended  
**LENGTHS** 49.25" | 98.5"  
**LENS** Frosted  
**FINISH** Silver

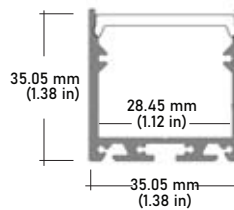

**ALP-140** Surface, Suspended  
**LENGTHS** 49.25" | 98.5"  
**LENS** Frosted  
**FINISH** Silver

## COMPATIBLE TRANSFORMERS

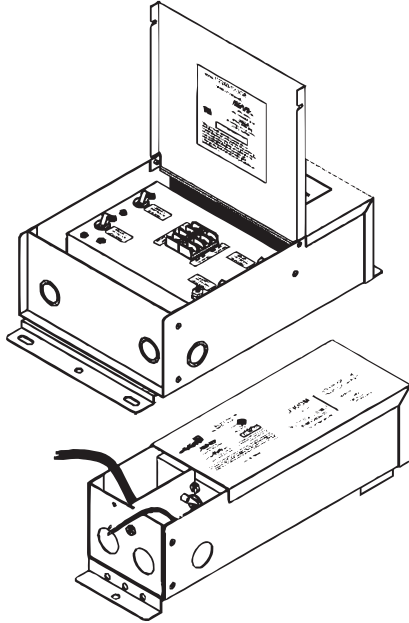

### PSDH SERIES | HIGH PERFORMANCE MAGNETIC LOW VOLTAGE (MLV)

<b>PSDH-48W-24V</b>	CLASS 2	11.25"x 3.37"x 3.25"
<b>PSDH-96W-24V</b>	CLASS 2	11.25"x 3.37"x 3.25"
<b>PSDH-288W-24V</b>	CLASS 2	14.25"x 8.43"x 4.43"

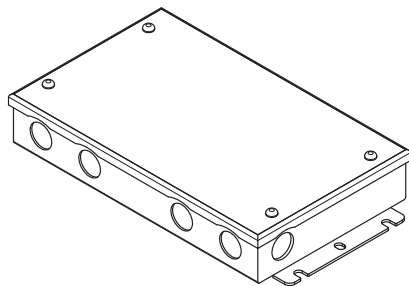

### PSDL SERIES | TRIAC DIMMABLE

<b>PSDL-30W-24V</b>	CLASS 2	6.5"x 3.63"x 1.03"
<b>PSDL-60W-24V</b>	CLASS 2	7.4"x 3.63"x 1.03"
<b>PSDL-96W-24V</b>	CLASS 2	8.67"x 3.67"x 1.62"
<b>PSDL-150W-24V</b>		8.67"x 3.67"x 1.62"
<b>PSDL-192W-24V</b>	CLASS 2	10.25"x 4.06"x 1.82"
<b>PSDL-200W-24V</b>		10.25"x 4.06"x 1.82"
<b>PSDL-288W-24V</b>	CLASS 2	10.25"x 4.06"x 1.82"
<b>PSDL-300W-24V</b>		10.25"x 4.06"x 1.82"

## COMPATIBLE TRANSFORMERS

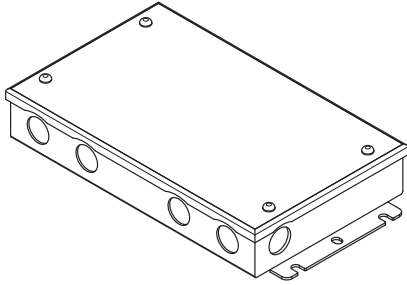

### PSHK SERIES | NON-DIMMING W/ JUNCTION BOX

<b>PSHK-30W-24V-UNV</b>	CLASS 2	6.5" X 3.6" X 1.02"
<b>PSHK-60W-24V-UNV</b>	CLASS 2	7.4" X 3.62" X 1.02"
<b>PSHK-96W-24V-UNV</b>	CLASS 2	8.66" X 3.66" X 1.61"
<b>PSHK-150W-24V-UNV</b>		10.24" X 4.06" X 1.81"
<b>PSHK-200W-24V-UNV</b>		10.24" X 4.06" X 1.81"
<b>PSHK-300W-24V-UNV</b>		10.94" X 4.25" X 1.81"



### PSDE SERIES | 0-10V DIMMING W/ JUNCTION BOX

<b>PSDE-100W-24V-010-JB</b>	CLASS 2	12.32" x 1.77" x 1.67"
-----------------------------	---------	------------------------



## COMPATIBLE TRANSFORMERS

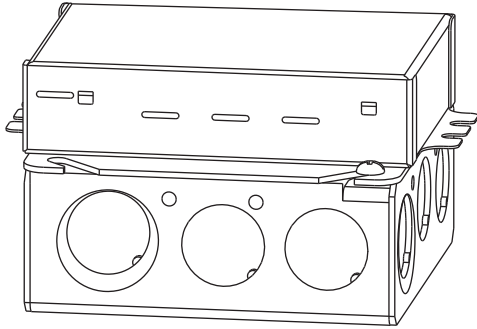

**LUTRON 1% | 2 OR 3-WIRE DIMMING**

**LTEA4U1UKL-CV240** CLASS 2 4.0" x 1.5" x 4.0"

**L3DA4U1UKL-CV240** CLASS 2 4.0" x 1.5" x 4.0"

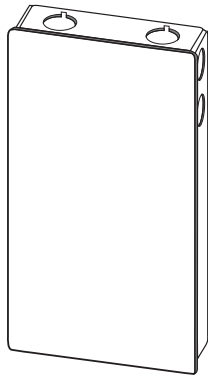

**LUTRON 1%**

**PSDE-96W-24V-ECO** CLASS 2 10.5" x 3.0" x 2.0"

# LSM75HF

7W Indoor Flexible LED Strip

## COMPATIBLE TRANSFORMERS

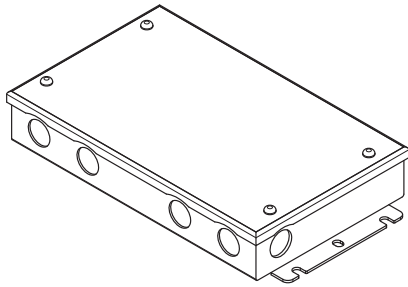

### PSVT SERIES | 0-10V DIMMING DRIVER

<b>PSVT-60W-24V</b>	CLASS 2	7.4" X 3.72" X 1.57"
<b>PSVT-96W-24V</b>	CLASS 2	8.66" X 3.72" X 1.57"
<b>PSVT-200W-24V</b>		10.24" X 4.13" X 1.77"
<b>PSVT-288W-24V</b>	CLASS 2	11.85" X 4.25" X 1.81"
<b>PSVT-300W-24V</b>		10.94" X 4.33" X 1.77"

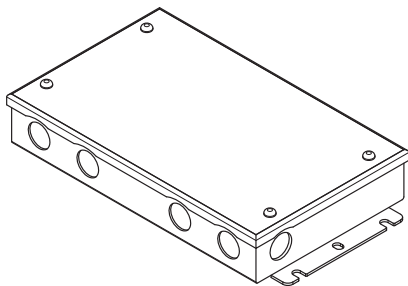

### PSRX SERIES | 4-in-1 DIMMING DRIVER W/ JUNCTION BOX

<b>PSRX-30W-12V-UNV</b>	CLASS 2	6.5" X 3.7" X 1.57"
<b>PSRX-60W-12V-UNV</b>	CLASS 2	7.4" X 3.72" X 1.57"
<b>PSRX-150W-12V-UNV</b>		10.24" X 4.13" X 1.77"
<b>PSRX-30W-24V-UNV</b>	CLASS 2	6.5" X 3.7" X 1.57"
<b>PSRX-60W-24V-UNV</b>	CLASS 2	7.4" X 3.72" X 1.57"
<b>PSRX-96W-24V-UNV</b>	CLASS 2	10.24" X 4.13" X 1.77"
<b>PSRX-150W-24V-UNV</b>		10.24" X 4.13" X 1.77"
<b>PSRX-200W-24V-UNV</b>		10.24" X 4.13" X 1.77"
<b>PSRX-300W-24V-UNV</b>		10.94" X 4.33" X 1.77"

## QUICK CONNECTORS

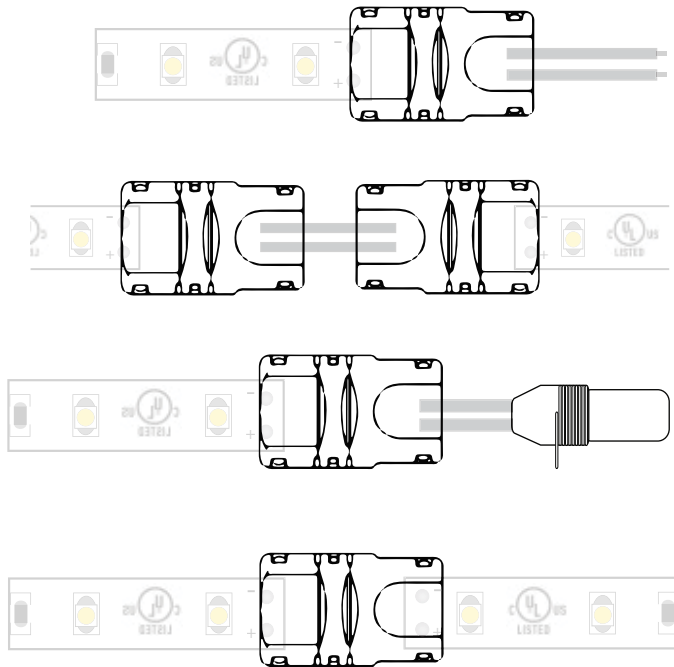

### HP PRO CONNECTORS | QUICK CONNECT SNAP-ON

**LSA-HW8-HP-X12** 8" CONNECTOR  
**LSA-HW24-HP-X12** 24" CONNECTOR  
**LSA-HW60-HP-X12** 60" CONNECTOR  
**LSA-HW120-HP-X12** 120" CONNECTOR

**LSA-EX3-HP-X12** 3" LINK  
**LSA-EX8-HP-X12** 8" LINK  
**LSA-EX24-HP-X12** 24" LINK

**LSA-DC24-HP-X12** 24" DC CONNECTOR

**LSA-MC-HP-X12** MINI COUPLING