

# LSM-30

## 3W INDOOR FLEXIBLE LED STRIP

Project \_\_\_\_\_

Location \_\_\_\_\_

Quote/ Ref # \_\_\_\_\_

**LSM-30** is a dimmable flexible LED strip capable of delivering 250 lumens of light output per ft. Suitable for use in cove lighting, under cabinets, architectural and aesthetic enhancements. It features superior CRI and different color temperature options.



### SPECIFICATIONS

INPUT VOLTAGE	12V   24V DC
POWER CONSUMPTION	3W per Ft.
NO. OF LEDs	36 LEDs per Ft.
LUMEN OUTPUT	223 Lm/Ft. (3000K)
CRI	95+
COLOR TEMPERATURE	22K / 24K / 27K / 30K / 35K / 40K / 50K / 60K / RD / BL / GR / PK / PR / AM / OR
DIMMING	MLV, ELV, 0-10 AND TRIAC
MAXIMUM RUN LENGTH	16.4 Ft. (12V) 24 FT. (24V)
CUTTABLE	Every 1 in (25.4mm) (12V) Every 1.96 in (49.9mm) (24V)
BINNING	1.5 Step Macadam Elipse
OPERATING TEMPERATURE	-40°F (-40°C) ~ +140°F (+60°C)
BEAM ANGLE	120°
IP RATING	Dry location (Indoor)
CERTIFICATIONS	UL Listed, TITLE 24 JA8
LUMEN MAINTENANCE	50,000 Hrs.

### LUMENS

CCT	LM/ FT	CRI	R9	R13
2200K	217	87	46	91
2400K	227	94	78	97
2700K	234	96	86	98
3000K	223	95	87	98
3500K	233	93	83	96
4000K	241	95	99	99
5000K	252	94	95	98
6000K	265	87	68	92
RED	98	-	-	-
GREEN	300	-	-	-
BLUE	71	-	-	-

\*Approved for closet / storage space installation per NEC 410.16(A)(3) and 410.16(C)(5)



MODEL	COLOR TEMP		LENGTH	VOLTAGE	PROFILE
<b>LSM30</b>	<b>22K</b> 2200K	<b>RD</b> Red	<b>16</b> 16 Ft.	<b>12V</b> 12V	<i>See Page 3 for compatible profiles.</i>
	<b>24K</b> 2400K	<b>BL</b> Blue	<b>100</b> 100 Ft.	<b>24V</b> 24V DC	
	<b>27K</b> 2700K	<b>GR</b> Green	<b>1XX</b> per Ft.		
	<b>30K</b> 3000K	<b>PK</b> Pink			
	<b>35K</b> 3500K	<b>PR</b> Purple			
	<b>40K</b> 4000K	<b>AM</b> Amber			
	<b>50K</b> 5000K	<b>OR</b> Orange			
	<b>60K</b> 6000K				
		*1 = Custom length per FT. (12V Strip cuttable every 1") (24V Strip cuttable every 1.96")			* Custom color finishes require powder coating. Allow 7 days leads time.

# LSM-30

## 3W INDOOR FLEXIBLE LED STRIP

### DIMENSIONS

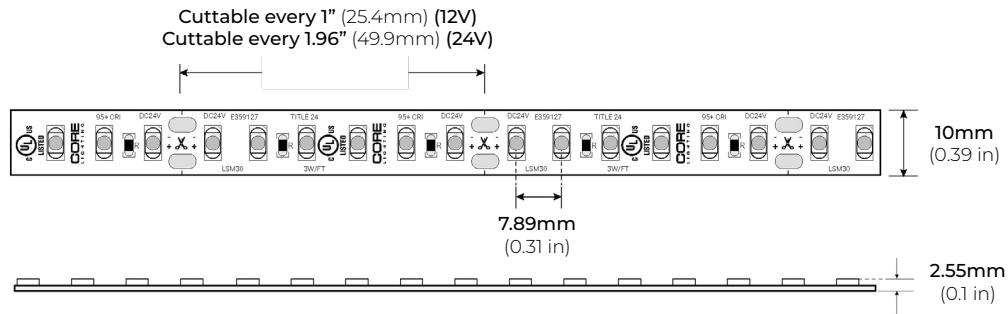

### COMPATIBLE CONNECTORS

#### HP PRO CONNECTORS

QUICK CONNECT SNAP-ON

- LSA-HW8-HP 8" HARDWIRE CONNECTOR
- LSA-HW24-HP 24" HARDWIRE CONNECTOR
- LSA-HW60-HP 60" HARDWIRE CONNECTOR
- LSA-HW120-HP 120" HARDWIRE CONNECTOR

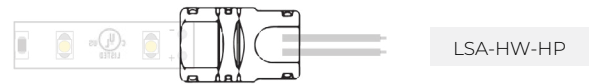

- LSA-EX3-HP 3" LINK
- LSA-EX8-HP 8" LINK
- LSA-EX24-HP 24" LINK

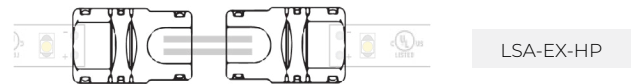

- LSA-MC-HP MINI COUPLING



- LSA-DC24-HP 24" DC CONNECTOR

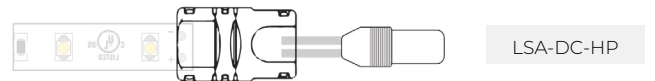

#### LSA-TB

SOLDERLESS LED STRIP/ WIRE BLOCK CONNECTOR

- LSA-TB-HWC 6A HARDWIRE CONNECTOR
- LSA-TB-MC STRIP TO STRIP COUPLING
- LSA-TB-HWP-10A 10A HARDWIRE CONNECTOR

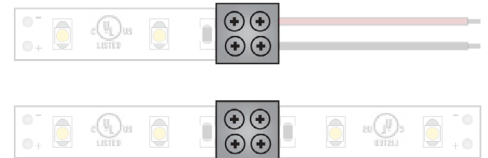
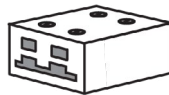

# LSM-30

## 3W INDOOR FLEXIBLE LED STRIP

### COMPATIBLE ALUMINUM PROFILES

#### SURFACE PROFILES

##### ALU-SF

LENGTHS 39" | 78" | 84" | 98"  
LENS Clear, Frosted  
FINISH Black | Silver

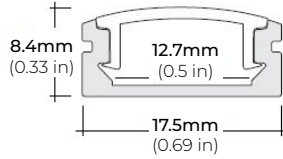

##### ALU-DS100

LENGTHS 39" | 78" | 84"  
LENS Clear, Frosted  
FINISH Silver

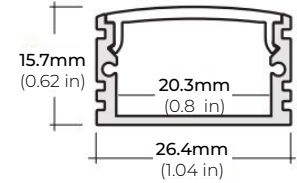

##### ALU-CN (CORNER)

LENGTHS 39" | 78" | 84" | 96"  
LENS Clear, Frosted  
FINISH Silver

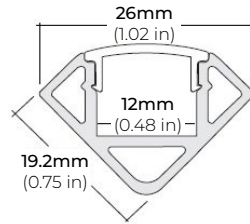

##### ALP-20

LENGTHS 49" | 84" | 98"  
LENS Frosted  
FINISH White | Black | Silver

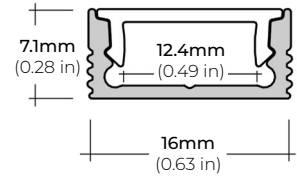

##### ALP-35

LENGTHS 48" | 96"  
LENS Frosted  
FINISH White | Black | Silver

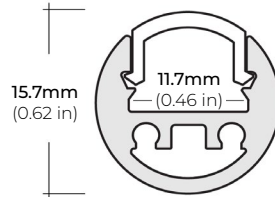

##### ALP-50C (CORNER)

LENGTHS 48" | 84" | 98"  
LENS Frosted  
FINISH Black | Silver

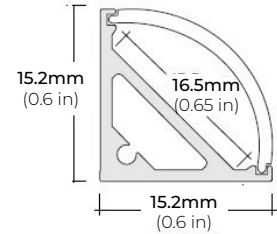

##### ALP-60

LENGTHS 49" | 84" | 98"  
LENS Frosted  
FINISH White | Black | Silver

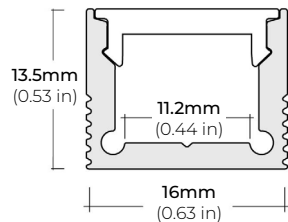

##### ALP-65

LENGTHS 48" | 84"  
LENS Clear  
FINISH Silver

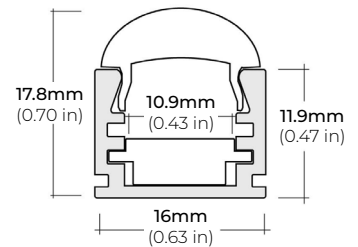

##### ALP-70

LENGTHS 49" | 84" | 98"  
LENS Frosted  
FINISH Black | Silver

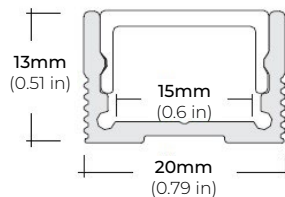

##### ALP-80

LENGTHS 49" | 98"  
LENS Frosted  
FINISH Silver

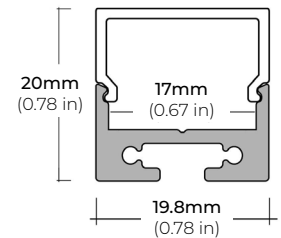

\* For more compatible profiles, visit [corelightingusa.com](http://corelightingusa.com)

#### RECESSED PROFILES

##### ALP-20R

LENGTHS 49" | 98"  
LENS Frosted  
FINISH White | Black | Silver

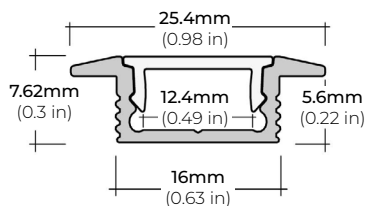

##### ALP-60R

LENGTHS 49" | 84" | 98"  
LENS Frosted  
FINISH White | Black | Silver

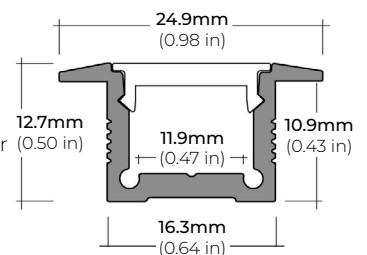

\* For more compatible profiles, visit [corelightingusa.com](http://corelightingusa.com)

# LSM-30

## 3W INDOOR FLEXIBLE LED STRIP

### COMPATIBLE TRANSFORMERS

#### PSDL SERIES TRIAC DIMMABLE

PSDL-30W-12V	CLASS 2	6.5" X 3.63" X 1.58"
PSDL-60W-12V	CLASS 2	7.4" X 3.63" X 1.58"
PSDL-100W-12V	CLASS 2	8.67" X 3.67 X 1.62"
PSDL-150W-12V		10.25" X 4.06" X 1.82"
PSDL-200W-12V		10.25" X 4.06" X 1.82"
PSDL-300W-12V		10.25" X 4.06" X 1.82"

PSDL-30W-24V	CLASS 2	6.5" X 3.63" X 1.58"
PSDL-60W-24V	CLASS 2	7.4" X 3.63" X 1.58"
PSDL-96W-24V	CLASS 2	8.67" X 3.67 X 1.62"
PSDL-150W-24V		10.25" X 4.06" X 1.82"
PSDL-192W-24V	CLASS 2	11" X 4" X 1.82"
PSDL-200W-24V		10.25" X 4.06" X 1.82"
PSDL-288W-24V	CLASS 2	11.85" X 4.25" X 1.82"
PSDL-300W-24V		10.25" X 4.06" X 1.82"

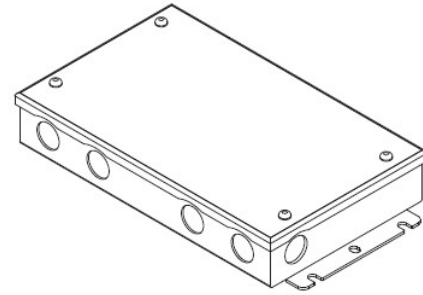

#### PSDH SERIES HIGH PERFORMANCE MAGNETIC LOW VOLTAGE (MLV)

PSDH-48W-24V	CLASS 2	11.25" X 3.38" X 3.38"
PSDH-96W-24V	CLASS 2	11.25" X 3.38" X 3.37"
PSDH-288W-24V	CLASS 2	14.25" X 8.43" X 4.43"

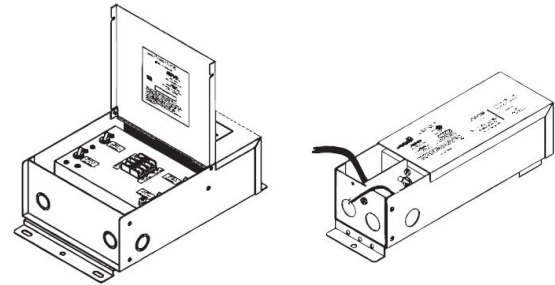

#### PSRX SERIES 4-IN-1 DIMMING DRIVER W/ JUNCTION BOX

PSRX-30W-12V-UNV	CLASS 2	6.5" X 3.72" X 1.57"
PSRX-60W-12V-UNV	CLASS 2	7.4" X 3.72" X 1.57"
PSRX-150W-12V-UNV		10.24" X 4.13" X 1.77"
PSRX-30W-24V-UNV	CLASS 2	6.5" X 3.7" X 1.57"
PSRX-60W-24V-UNV	CLASS 2	7.4" X 3.72" X 1.57"
PSRX-96W-24V-UNV	CLASS 2	8.66" X 3.72" X 1.57"
PSRX-150W-24V-UNV		10.24" X 4.13" X 1.77"
PSRX-200W-24V-UNV		10.24" X 4.13" X 1.77"
PSRX-300W-24V-UNV		10.94" X 4.33" X 1.77"

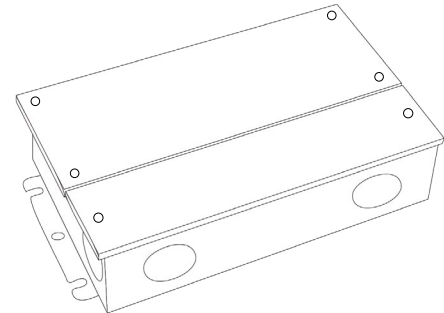

# LSM-30

## 3W INDOOR FLEXIBLE LED STRIP

### COMPATIBLE TRANSFORMERS

---

#### PSVT SERIES

0-10V DIMMING WITH JUNCTION BOX

PSVT-60W-24V-UNV-010	CLASS 2	7.4" X 3.72" X 1.57"
PSVT-96W-24V-UNV-010	CLASS 2	8.66" X 3.72" X 1.57"
PSVT-200W-24V-UNV-010		10.24" X 4.13" X 1.77"
PSVT-288W-24V-UNV-010	CLASS 2	11.85" X 4.25" X 1.81"
PSVT-300W-24V-UNV-010		10.94" X 4.33" X 1.77"

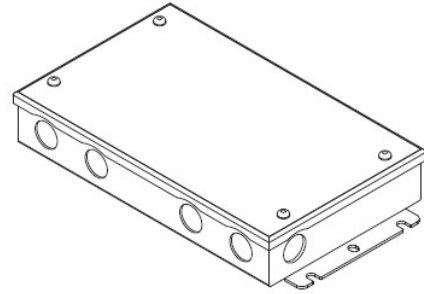

---

#### PSDE SERIES

0-10V DIMMING W/ JUNCTION BOX

PSDE-60W-24V-010-JB	CLASS 2	12.1" X 2.36" X 1.4"
PSDE-96W-24V-010-JB	CLASS 2	12.1" X 2.36" X 1.4"

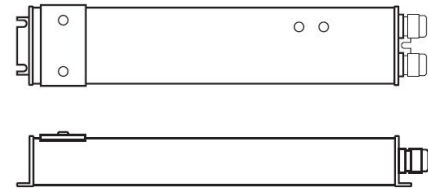

---

#### LUTRON 1%

3-WIRE DIMMING

L3DA4U1UKL-CV240	CLASS 2	4.89" X 4" X 2.62"
------------------	---------	--------------------

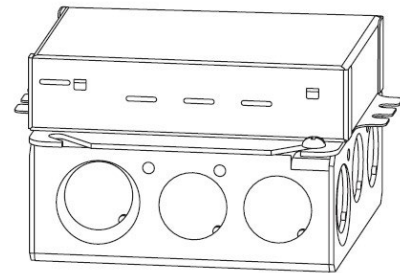

---

#### LUTRON 1%

PSDE-96W-24V-ECO	CLASS 2	10.5" X 3.0" X 2.0"
------------------	---------	---------------------

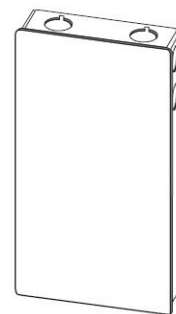

# LSM-30

## 3W INDOOR FLEXIBLE LED STRIP

### COMPATIBLE NON-DIMMING DRIVERS

#### PSHK SERIES

NON-DIMMING CONSTANT VOLTAGE WITH JUNCTION BOX

PSHK-30W-24V	CLASS 2	6.5" X 3.6" X 1.02"
PSHK-60W-24V	CLASS 2	7.4" X 3.62" X 1.02"
PSHK-96W-24V	CLASS 2	8.66" X 3.66" X 1.61"
PSHK-150W-24V		10.24" X 4.06" X 1.81"
PSHK-200W-24V		10.24" X 4.06" X 1.81"
PSHK-288W-24V	CLASS 2	11.85" X 4.25" X 1.82"
PSHK-300W-24V		10.94" X 4.25" X 1.81"

