

Linear Highbay: C-Line

4-CCT & 3-Power Selectable

Linear Highbay



165W, 220W, 320W Adjustable Lens

Angle Adjustable

WATT	LUMENS
60	9,000
110	16,500
165	24,750
180	27,000
200	30,000
220	33,000
260	39,000
290	43,500
320	48,000
380	57,000
410	61,500
440	66,000



440W Non-Adjustable Lens
3P440W

Detail Specifications

- Finish: White, Custom finishes available
- IP Rating: Damp Location
- Beam Angle: 110°
- Chip: SMD 2835, R9 >50, CRI >80
- Operating Temperature: -4° - 122° F
- Lens: Clear Prismatic Ribbed
 - Low Glare
- Average life (L70) of 70,000 hours

Applications:

- Warehouse/Distribution Facility
- Utility & Storage
- Garage Structures
- Commercial and Industrial

Product Information:

- Aluminum housing finished with corrosion free power coat
- Replace existing fixtures or use in new construction
- Compact design for easier installation
- Select-n-Switch Technology: 4-CCT + 3-Power Selectable
- Twist-C Control: Control ready receptacle built into each fixture
 - Standard Sensors
 - SILVAIR Bluetooth Mesh
 - ENVISIONLS Bluetooth
 - [Click Here](#) for More Information

Driver Options:

- UNV: 120-277V 0-10V Dimmable
- HV: 277-480V 0-10V Dimmable
- THD: <15% (+/-5% tolerance), PF >0.9, 50/60Hz

Mounting & Installation:

- 3.5' adjustable suspension kit included
- Optional 10 & 20' adjustable suspension kit available
- Optional 6' chain kit available
- Optional surface mount kit available
- Optional pendant mount kit available

Certifications:

- UL Listed for USA and CA
- DLC Premium Listed
 - View DLC ID Chart below
- ROHS Compliant
- Approved for CA T24
- 5 Year Limited Warranty
- FCC CFR 47, GCC Part 15, Subpart B:2017

Series	Voltage	Whip ¹	Plug	EMB
LED-LHB-1FT-3P165-4CCT 60/110/165W • 120-277V	UNV 120-277V	(Blank) No Whip	(Blank) Hardwire	(Blank) No
LED-LHB-2FT-3P220-4CCT 180/200/220W • 120-277V	HV 277-480V	-6 6ft Whip	SB 5-15P	Emergency Back-Up
LED-LHB-2FT-3P320-4CCT 260/290/320W • 120-277V		-10 10ft Whip	TL Plug	EMB 90 Min.
LED-LHB-2FT-3P440-4CCT 380/410/440W • 120-277V		-20 20ft Whip	TL Twist Lock Plug	Emergency Back-up
		-6F 6' Whip		
		-5 5-Wire		
		-10F 10' Whip		
		-5 5-Wire		
		-20F 20' Whip		
		-5 5-Wire		

1. 3-wire: for non-dimming or twist-c sensor applications.
5-wire: for 0-10v dimming applications. Emergency models will ship standard with extra emergency wire.

Optional Accessories (Order Separately)					
Suspension Kits	Mounting Kits	Wire Guards	Whips (Field Install)	Sensors ¹	Sensor Remote
SK-10FT-Y-LC-PD 10' Y-Shape, Loop Top, Paddle Bottom (Adjustable Length)	LHB-3P-PDM 165W, 220W, 320W Pendant Mount Kit	LHB-3P165 -1FT-WG LHB-3P220 -2FT-WG	6'-WHIP-1/2KO 6' Whip	S-TWC-PIR-ON/OFF PIR Sensor On/Off Only 5/10/15min	S-LINE-R Remote for S-TWC-PIR-1 (Required)
SK-20FT-Y-LC-PD 20' Y-Shape, Loop Top, Paddle Bottom (Adjustable Length)	LHB-3P440-PDM 440W Pendant Mount Kit	LHB-3P320 -2FT-WG LHB-3P440 -2FT-WG	10'-WHIP-1/2KO 10' Whip	S-TWC-PIR-1 PIR Bi-Level Motion + Daylight Sensor (Remote Req'd)	SILVAIR Bluetooth mesh. Download on Apple or Android app store.
SK-10FT-Y-LC-CB 10' Y-Shape, Loop Top, Carabiner Bottom (Adjustable Length)	LHB-3P-SM 165W, 220W, 320W Surface Mount Kit		20'-WHIP-1/2KO 20' Whip	S-TWC-PIR-SL PIR SILVAIR Bluetooth Mesh	ENVISIONLS Bluetooth smart app. Download on Apple or Android app store.
SK-20FT-Y-LC-CB 20' Y-Shape, Loop Top, Carabiner Bottom (Adjustable Length)	LHB-3P440-SM 440W Surface Mount Kit		Custom whips to size available	S-TWC-PIR-BT PIR ENVISIONLS Bluetooth Control	
CK-6FT-V 6' chain hanging kit					

1. Sensor Note:
Microwave: Detects motion through barriers such as walls, and doors. Ideal for applications where obstacles might obstruct the line of sight. Works effectively outdoors, in large open spaces, & parking lots. Do not use in areas of high vibrations or metal.
PIR: Ideal for indoor environments with clear lines of sight to the area of interest. Detects warm objects, like a person or animal. Good for high vibration, areas of metal.

Specs and model numbers are subject to change with or without notice.

FEATURES

165W, 220W, 320W Adjustable Lens



FEATURES

440W Non-Adjustable Lens

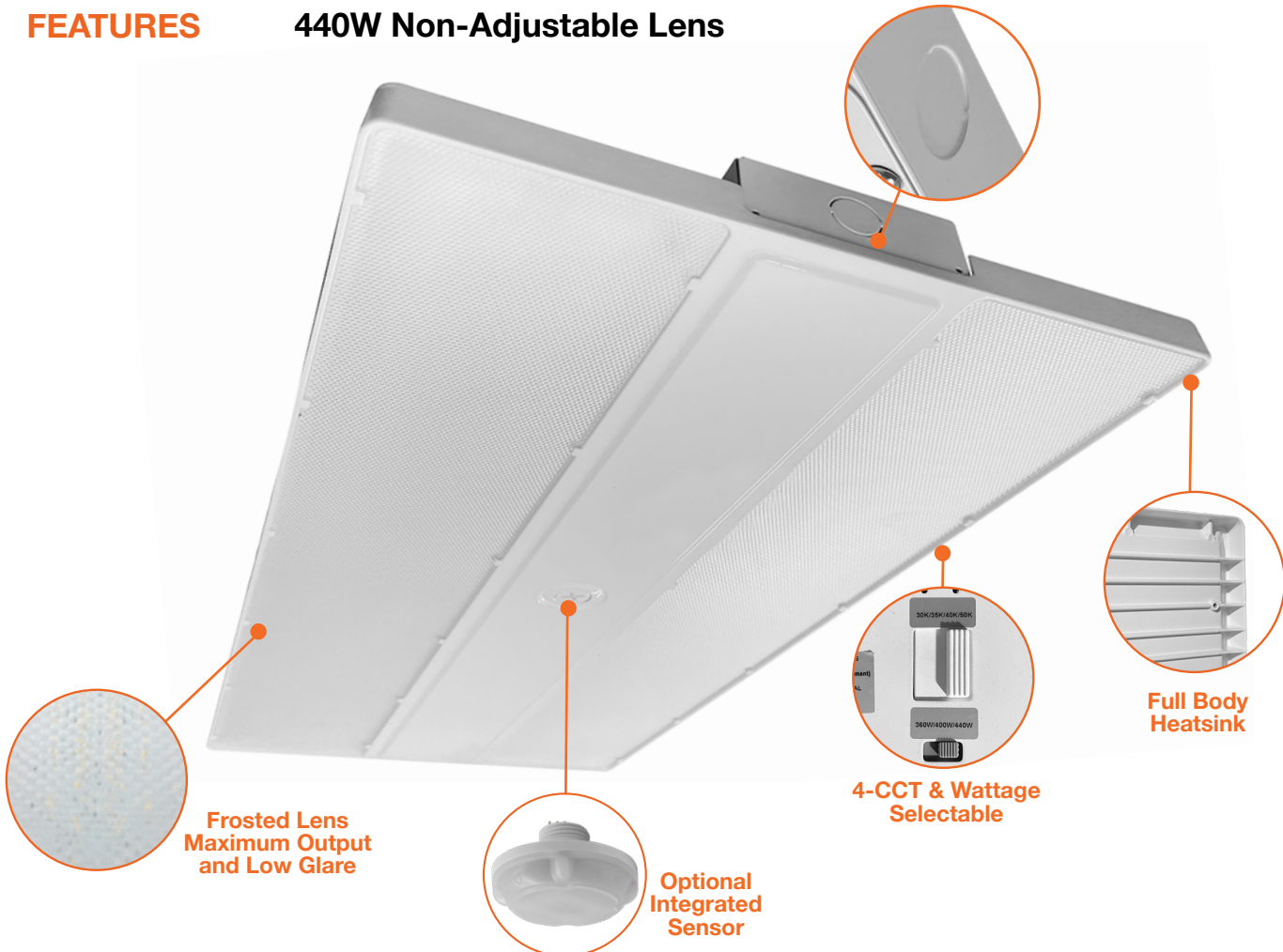

DIMENSIONS

3P165

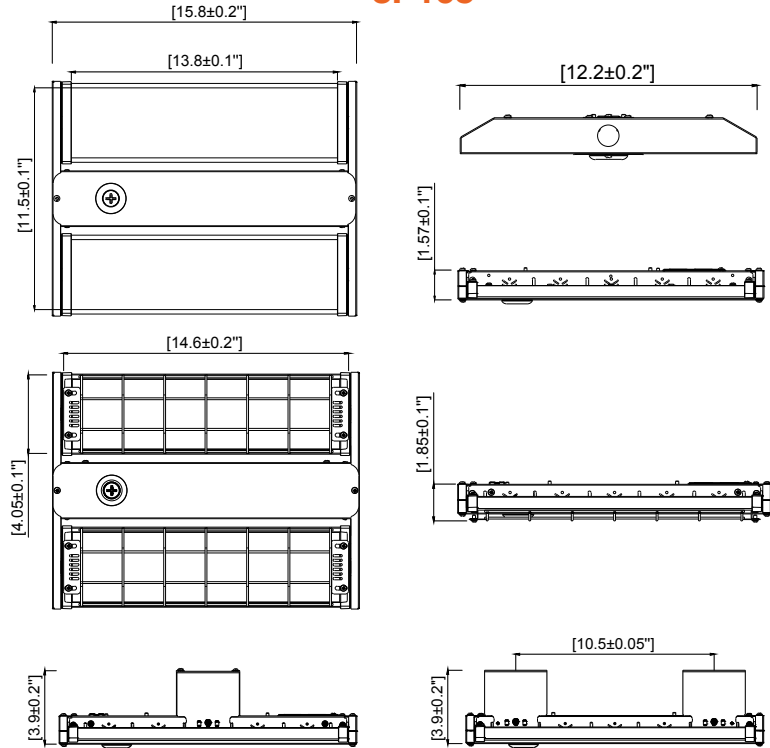

3P220

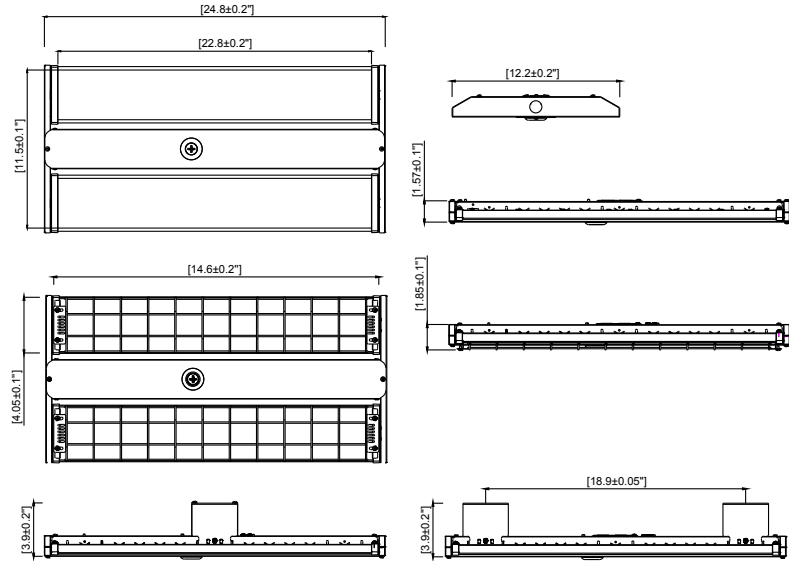

3P320

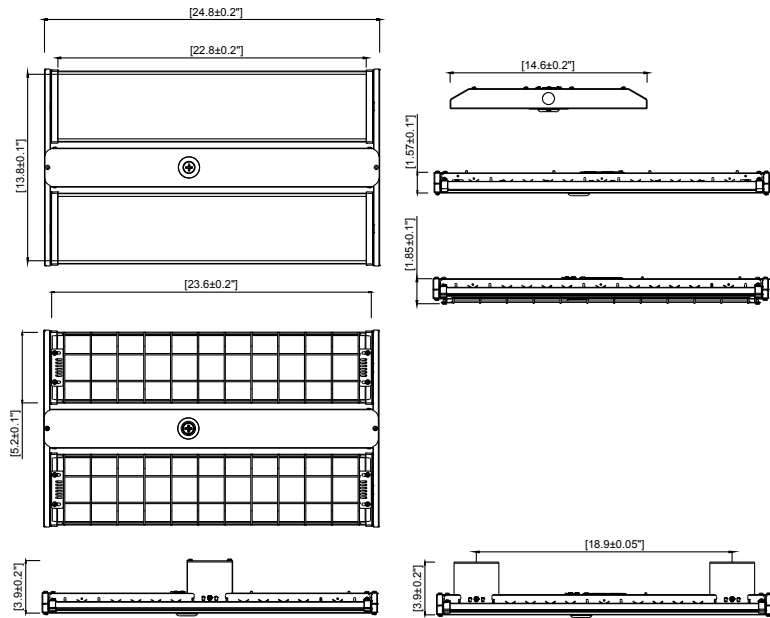

3P440

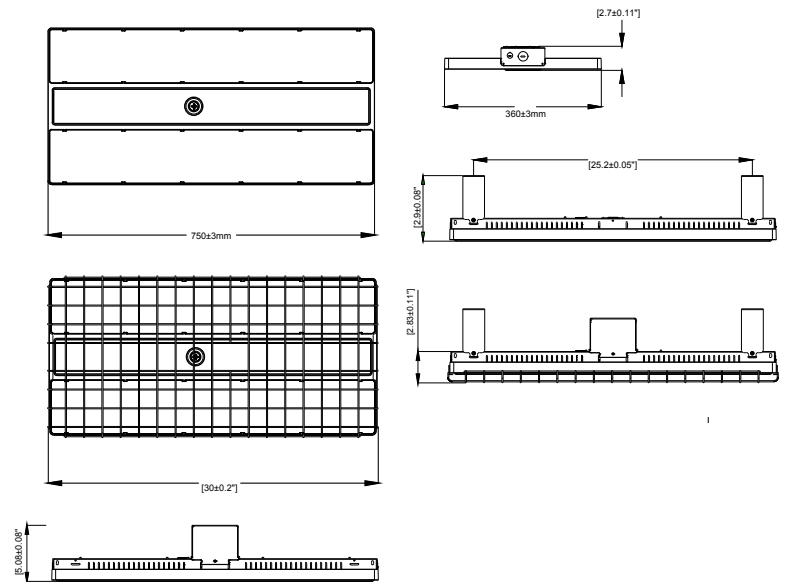

High Bay Luminaires - DLC Product ID:

LED-LHB-1FT-3P165-4CCT-UNV	S-AEGVNR
LED-LHB-1FT-3P165-4CCT-HV	S-FJZYQ7
LED-LHB-2FT-3P220-4CCT-UNV	S-6TDE93
LED-LHB-2FT-3P220-4CCT-HV	S-ILEASF
LED-LHB-2FT-3P320-4CCT-UNV	S-VE063Y
LED-LHB-2FT-3P320-4CCT-HV	S-NHTM6B
LED-LHB-2FT-3P440-4CCT-UNV	S-LZ12N3
LED-LHB-2FT-3P440-4CCT-HV	S-H7UMVD

ACCESSORIES



SK-10FT-Y-LC-PD
SK-20FT-Y-LC-PD

SK-10FT-Y-LC-CB
SK-20FT-Y-LC-CB

CK-6FT-V

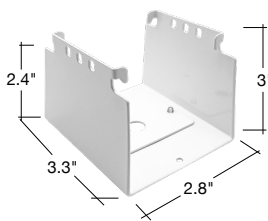
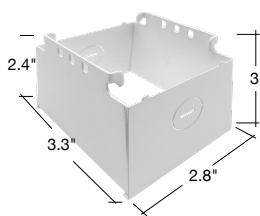

Pendant Mount 2ft
LHB-2FT-3P-PDM
Center Hole Size .85"

Surface Mount 2ft
(2 Pcs)
LHB-2FT-3P-SM
Center Hole Size 1"
Center Hole Size
w/ Plate .43"

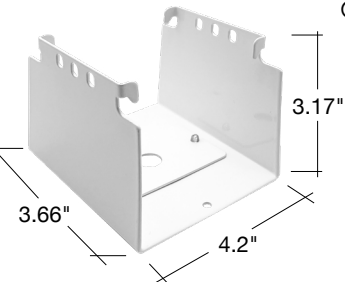

Surface Mount 4ft (2 Pieces)
LHB-4FT-SM

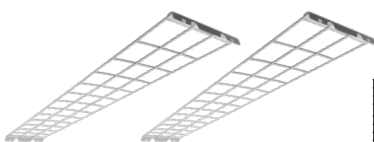

Wire Guards
LHB-3P-2FT-WG

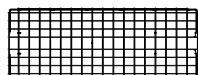

Wire Guards
LHB-3P440-2FT-WG



6'-WHIP-1/2KO
10'-WHIP-1/2KO
20'-WHIP-1/2KO



S-TWC-PIR-1
S-TWC-PIR-SL
S-TWC-PIR-BT



S-TWC-PIR
-ON/OFF



S-LINE-R
Controller



SB
5-15P Straight
Blade Plug



TL
L5-15P Twist
Lock Plug

HIGHBAY FIXTURE

Model	Voltage	Watts	Lumens	Color	CRI
LED-LHB-1FT-3P165-4CCT-UNV	120-277V	60/110/165w	145lm/w	30/35/40/50k	>80
LED-LHB-1FT-3P165-4CCT-HV	277-480V	60/110/165w	145lm/w	30/35/40/50k	>80
LED-LHB-2FT-3P220-4CCT-UNV	120-277V	180/200/220w	145lm/w	30/35/40/50k	>80
LED-LHB-2FT-3P220-4CCT-HV	277-480V	180/200/220w	145lm/w	30/35/40/50k	>80
LED-LHB-2FT-3P320-4CCT-UNV	120-277V	260/290/320w	145lm/w	30/35/40/50k	>80
LED-LHB-2FT-3P320-4CCT-HV	277-480V	260/290/320w	145lm/w	30/35/40/50k	>80
LED-LHB-2FT-3P440-4CCT-UNV	120-277V	380/410/440w	145lm/w	30/35/40/50k	>80
LED-LHB-2FT-3P440-4CCT-HV	277-480V	380/410/440w	145lm/w	30/35/40/50k	>80

SUSPENSION KITS

Accessory	Description
SK-10FT-Y-LC-PD	10' Y-Shape, Loop Top, Paddle Bottom (Adjustable Length)
SK-20FT-Y-LC-PD	20' Y-Shape, Loop Top, Paddle Bottom (Adjustable Length)
SK-10FT-Y-LC-CB	10' Y-Shape, Loop Top, Carabiner Bottom (Adjustable Length)
SK-20FT-Y-LC-CB	20' Y-Shape, Loop Top, Carabiner Bottom (Adjustable Length)
CK-6FT-V	6' Chain Hanging Kit

MOUNTING KITS

Accessory Model	Description
LHB-3P-PDM	LHB: Pendant mount bracket up to 320W
LHB-3P440-PDM	LHB: Surface mount bracket up to 440W
LHB-3P-SM	LHB: Surface mount bracket up to 320W
LHB-3P440-SM	LHB: Surface mount bracket up to 440W

WIRE GUARDS

Accessory Model	Description
LHB-3P165-1FT-WG	LHB: Wire Guard 1ft 3P165
LHB-3P220-2FT-WG	LHB: Wire Guard 2ft 3P220
LHB-3P320-2FT-WG	LHB: Wire Guard 2ft 3P320
LHB-3P440-2FT-WG	LHB: Wire Guard 2ft 3P440

WHIPS (FIELD INSTALL)

Accessory Model	Description
6'-WHIP-1/2KO	6' Whip
10'-WHIP-1/2KO	10' Whip
20'-WHIP-1/2KO	20' Whip

SENSORS

Accessory	Description
S-TWC-PIR-ON/OFF	PIR Sensor On/Off Only 5/10/15min
S-TWC-PIR-1	PIR Bi-Level Motion + Daylight Sensor (Remote Req'd)
S-TWC-PIR-SL	PIR SILVAIR Bluetooth Mesh
S-TWC-PIR-BT	PIR ENVISIONLS Bluetooth Control

SENSOR REMOTE









Accessory Model	Description
S-LINE-R	Remote for S-Line Sensor
SILVAIR	Bluetooth mesh. Download on Apple or Android app store.
ENVISIONLS	Bluetooth smart app. Download on Apple or Android app store

PLUG

Accessory Model	Description
SB	5-15P Straight Blade Plug
TL	L5-15P Twist Lock Plug

EnVisionLED™ Control Options

EnVision LED offers 3 control systems compatible with our LED Fixtures for projects of all sizes and budgets.

	Basic Controls	EnVisionLS 	EnVisionLED™ X SILVAIR 
Description	Standard Plug In Sensors	Basic Bluetooth Wireless Control	Advanced Bluetooth Wireless Control
Recommended Quantity (but not limited to)	N/A	>40-50 Nodes	>50 Nodes
Maximum Zone Quantity	N/A	100	3,000
Commissioning Tool	Remote Only	  ENVISIONLS App 	  SILVAIR App 
Commissioning Process	Individually Set via Remote	Wireless Must be done on site	Wireless- Initial linking must be done on site. Commissioning can be done via desktop remotely.
Floor Plan Upload	N/A	N/A	Yes Add a floor plan and mark luminaires & zones via desktop
Gateway	N/A	N/A	Required only for energy monitoring, advanced scheduling, automated demand response.
Individual Luminaire Control	Yes	Yes	Yes
Luminaire Grouping Zoning	N/A	Yes	Yes
High End Power Low End Power	Yes but limited (View Remote)	Yes	Yes
Cost	\$	\$\$	\$\$\$
DLC NLC Listed	N/A	Yes	Yes
Energy Monitoring & Data Reporting	N/A	N/A	Monitor energy usage per individual zone & retrofit cost savings calculation + detailed reporting







Compatible Products:

EnVision offers a variety of nodes, sensors, & gateways that are controlled via remote, ENVISIONLS Bluetooth Mesh & SILVAIR Bluetooth Mesh on all of our 0-10V dimmable fixtures.





Individual Fixture Controls: PIR Sensor, Bi-Level Dimming, Daylight

Basic Note: **-1** • ENVISIONLS Models Note: **-BT** • SILVAIR Models Note: **-SL**

	MODEL #	DESIGN	RECOMMENDED FIXTURE	FEATURES
	S-TWC-PIR-1 S-TWC-PIR-BT S-TWC-PIR-SL	Twist-C Control Sensor	Sensor Ready Fixtures: Area Lights, Canopies, Flood Lights, High Bays	All models are equipped with PIR occupancy sensing, high & low end bi-level dimming, & daylight sensing.
	S-TWC-90 + S-TWC-PIR-1 S-TWC-90 + S-TWC-PIR-BT S-TWC-90 + S-TWC-PIR-SL	Twist-C Control Sensor + 90 Degree Arm	Cylinders, Strips, Wall Packs	
	S-AUD-PIR-1 S-AUD-PIR-BT S-AUD-PIR-SL	2.5m Audio Jack	Panels & Troffers	
	S-SN-PIR-1 S-SN-PIR-BT S-SN-PIR-SL	Snap In Sensor	Troffers & Wraps	

Group Controls ENVISIONLS Models Note : **-BT** • SILVAIR Models Note: **-SL**

	MODEL #	DESIGN	VOLTAGE	FEATURES	RECOMMENDED FEATURES
	S-CM-PIR-LV-BT S-CM-PIR-LV-SL	Ceiling Mounted PIR Sensor	12-24V	PIR Sensor, Bi-Level Dimming, Daylight, 360° detection, 12' Max Mounting Height	Connects to 0-10V dimmable fixtures
	S-WM-PIR-CUNV-BT S-WM-PIR-CUNV-SL	Wall Mounted PIR Occupancy Sensor, Bi-Level Dimming, Daylight	120-277V	On/Off PIR occupancy sensor, 180° detection, 30' detection @ 4' Mounting Height	Connects to LED fixtures
	S-WS-120V-USB-SL		120V	Dimming Wall Socket, Two Sockets	Floor Lamps, Other Lamps

Gateway (Silvair Only) 4.5–5.5 V DC, 2A Power over Ethernet 36–57 V DC

	MODEL #	DESIGN	VOLTAGE	FEATURES	RECOMMENDED FEATURES
	SGW-102	Wall or Ceiling Mounted	POE	Advanced Energy Monitoring Control	Connects to Silvair Controls. Gateway is not required.